SFC160S-E

Module

**Product
Specification**

Doc. VERSION 1.0

Startek Engineering Incorporated

July 2016



Contents

1	General Description	1
2	Features	1
3	Specification.....	2
4	Block Diagram	3
5	PIN Assignment.....	3
5.1	Connector wafer specification.....	3
5.2	Pin Assignment.....	3
6	Electrical Characteristics.....	3
6.1	Maximum Rating.....	3
6.2	Operating Condition.....	3
7	Application Information	4
7.1	Mechanical Support.....	4
7.2	ESD Protection.....	4
8	Mechanical Specifications.....	5
9	SDK Process Flowchart.....	6
9.1	Windows	6
9.2	Linux	8
10	ANSI/INCITS 378 Approval Authorization Letter	10



Specification Revision History

Doc. Version	Revision Description	Date
1.	Initial version	2017/4/21



1 General Description

SFC160S-E fingerprint image sensor is based on capacitive-contact technology with hardened surface and enhanced ESD resistivity. There are 160x160 sensor pixels to construct sensor area of $8.0 \times 8.0 \text{ mm}^2$ because each pixel size is $50 \times 50 \mu\text{m}^2$

The Build-in analog and digital circuitry minimizes the number of external component, and provides easy-to-use standard SPI interface to microprocessors. The operation of SFC160S-E is controlled through registers, following a simple protocol. The captured image quality can be adjusted by setting gain, offset or reference voltage parameters. The internal operation and interface speed can also be configured to the need.

This product is a mini fingerprint algorithm module and can be used with STARTEK's capacitive chip sensor reader .SFC160S-E has a wide range of applications but focuses mostly on authentication applications.

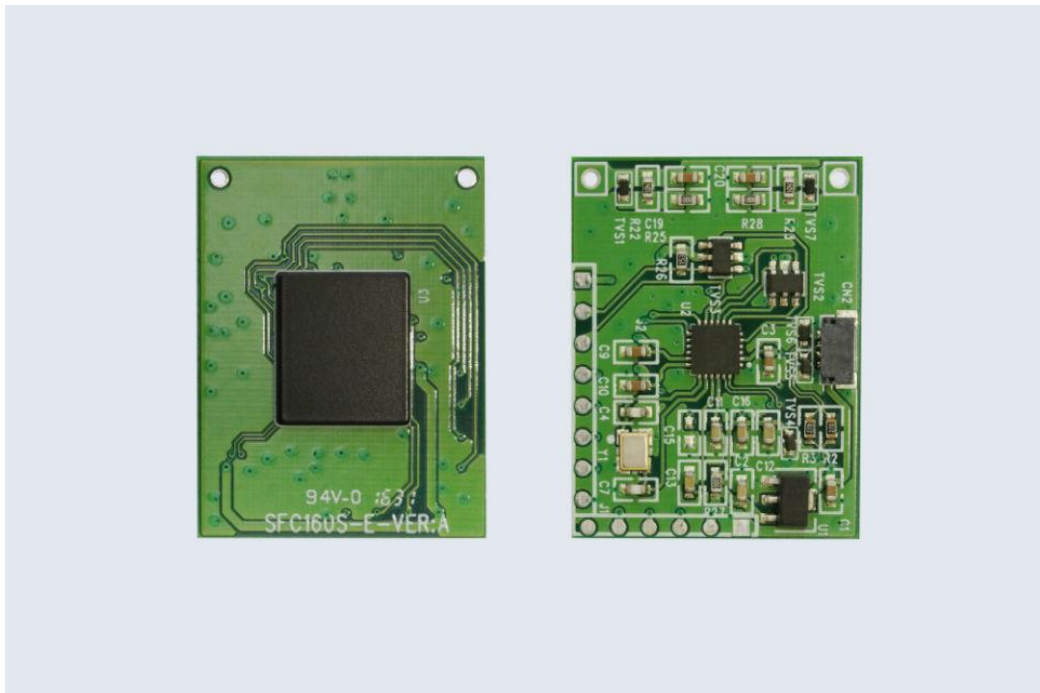

2 Features

- Performance: With high performance CPU, 1:1 and 1:N matching speed are both less than 1 second.
- Small Size: SFC160S-E is more cost effective and is flexible to be integrated to any device (Mobile/Tablet/Notebook)
- Easy Integration: It is very easy to capture fingerprint image, enroll and match fingerprint through USB interface.
- ISO Standard: ANSI/INCIT 378 Compliant Extractor & Matcher.



- Low Power Consumption
- Choice to set different security levels for different FRR/FAR demand
- Small template size
- Support verification on various platforms

■ Coating

Surface	Matte
Sensor Color	Black
Color number	Pantone 433C
RCA(175g)	>200

■ Control unit

- Operation voltage
 - ◆ System Operation voltage (suggested): 2.8~3.3V
- Operating temperature range: 0°C ~ 80°C

3 Specification

Sensors	Capacitive Chip sensor
Scanning Speed	30 Frame/sec
Image Resolution	508 dpi
Gray Level	8 bits/pixel, max 256 gray scales
Image Ratio of Length to Width	1 : 1
Interface	USB
Power	DC 5V (Suspend: <0.6mA, Matching duration: 25mA)
Dimension	31 x 24 mm
Operating Temperature	0°C ~ 70°C
Operating Humidity	0~95% Non-condense
Verification speed	1:1, 80 msec, 1:N 250 msec
FRR (False Rejection Rate)	1/100
FAR (False Acceptance Rate)	1/100,000
ESD	15 KV



4 Block Diagram

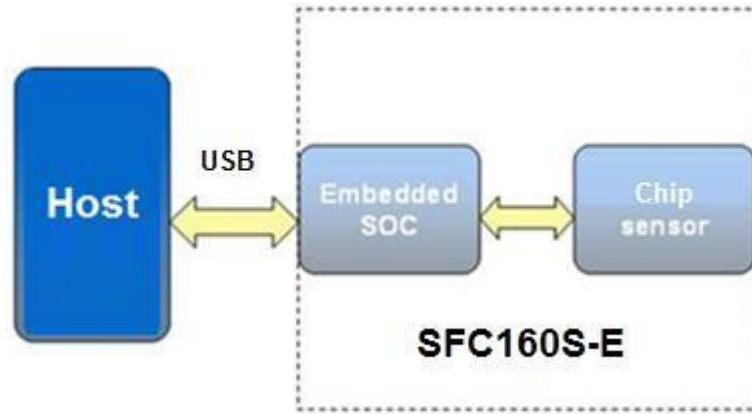

5 PIN Assignment

5.1 Connector wafer specification

Wafer 0.8mm Pitch 4 Pins

5.2 Pin Assignment

Pin Number	Name	Type	Pin Description
PIN1	VDD	Power	System Power, +5V
PIN2	D-	I/O	USB Signal
PIN3	D+	I/O	USB Signal
PIN4	GND	Power	System Ground

6 Electrical Characteristics

6.1 Maximum Rating

Symbol	Parameter	Value	Unit
VDD	Supply Voltage	-0.3 to 6	V
TA	Operating temperature	0 to 70	°C
SA	Storage temperature	-40 to 85	°C

6.2 Operating Condition

Symbol	Parameter	Min.	Typ.	Max.	Unit
VDD	Supply Voltage	4.75	5	5.25	V
IDD	Supply current (Operation)		25		mA
IDD	Supply current(Suspend)			0.6	MA
ESD	ESD Protection	15			kV



7 Application Information

7.1 Mechanical Support

The best way to ensure a solid sensor mount is to apply a stable, non-conductive support to the back side of the sensor component. This non-conductive support can preferably be attached to the entire back side area.

7.2 ESD Protection

The SFC160S-E has a robust sensor surface coating. Passive components are necessary to integrate the SFC160S-E into the system, including a Transient Voltage Suppressor (TVS) for Electrostatic Discharge (ESD) protection purposes, and de-couple capacitor.



8 Mechanical Specifications

Size: 24.0 mm x 31.0 mm

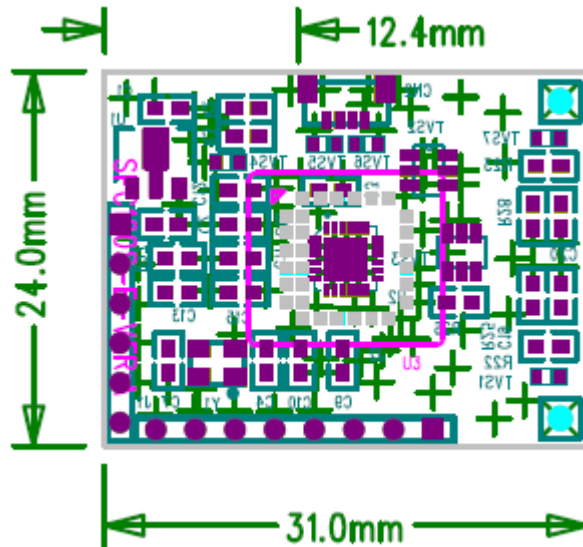



9 SDK Process Flowchart

9.1 Windows

The following diagram shows the simplified enrollment process flow :

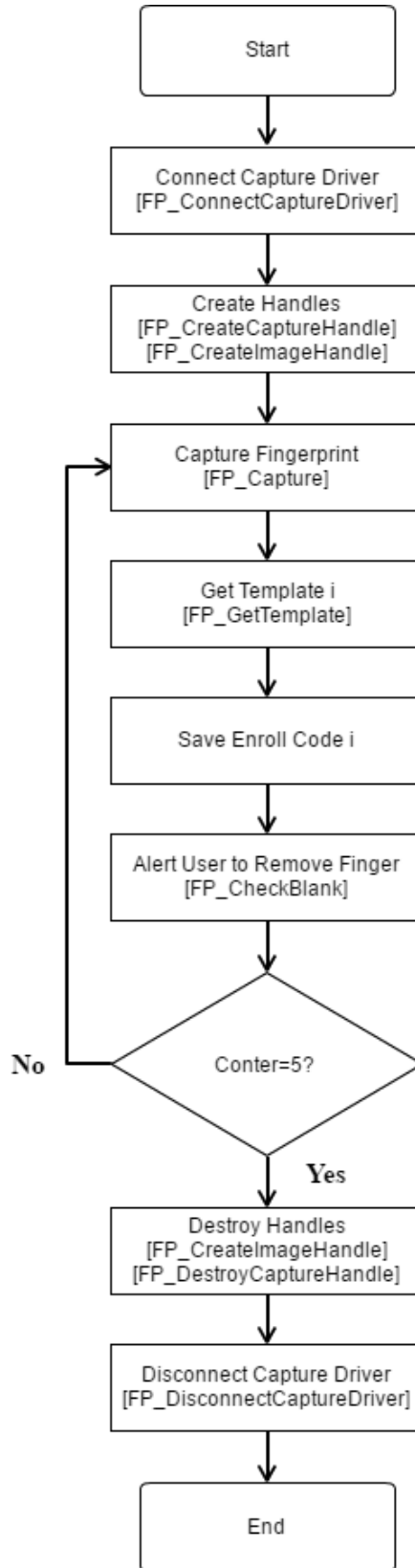



The following diagram shows the simplified verification process flow:

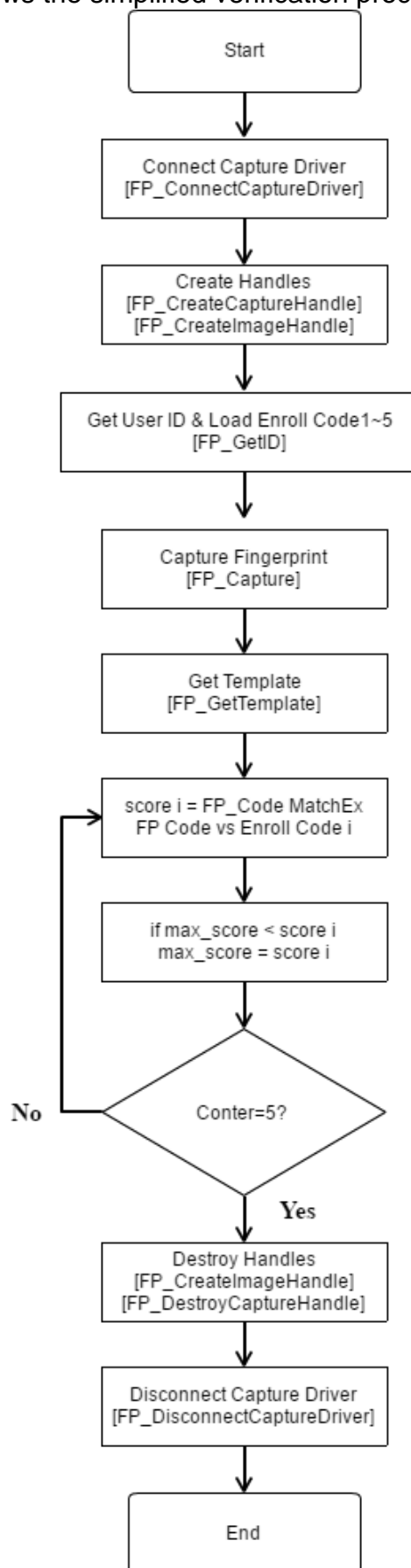



9.2 Linux

The following diagram shows the simplified enrollment process flow :

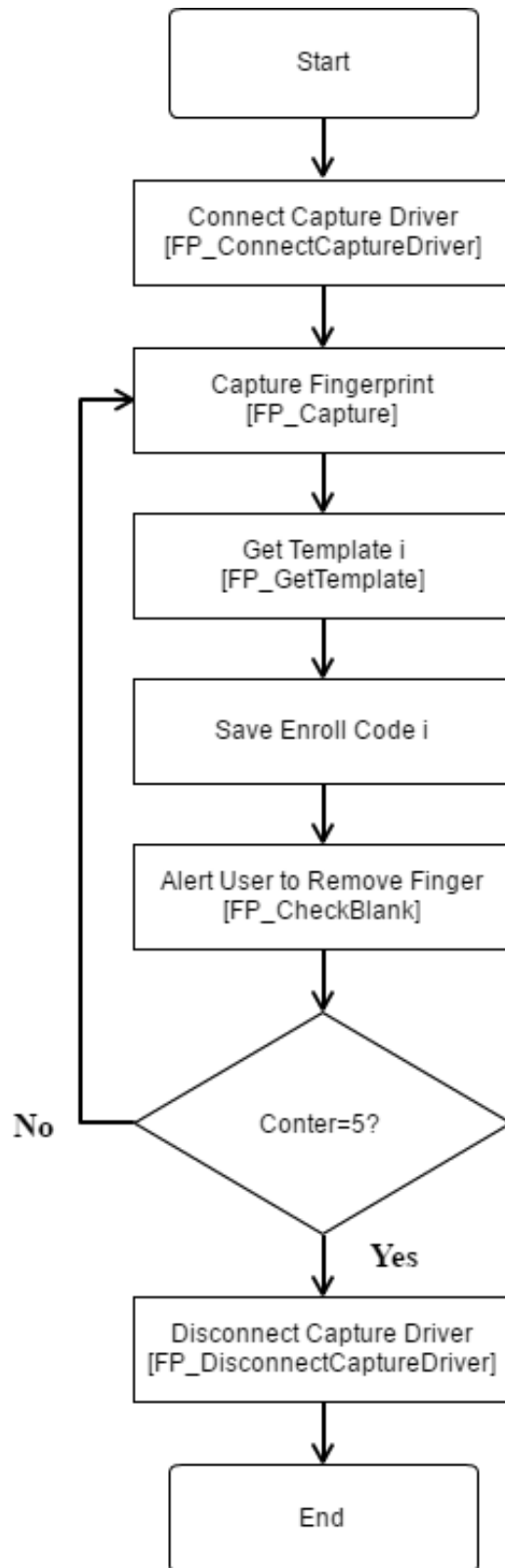



The following diagram shows the simplified verification process flow:

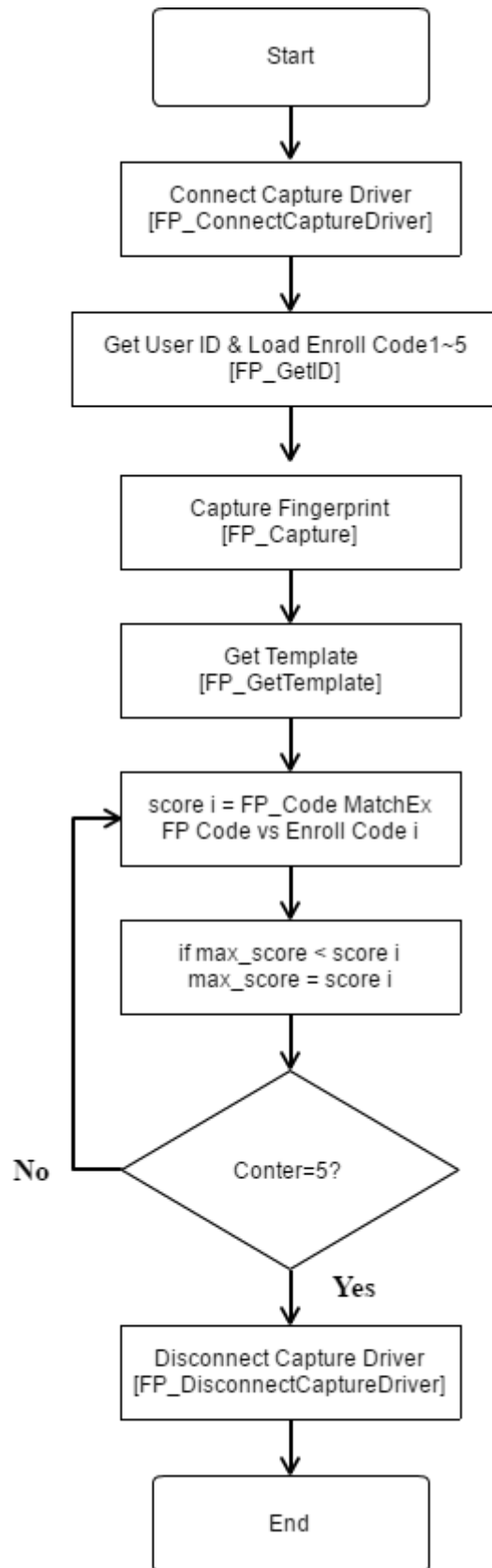



10 ANSI/INCITS 378 Approval Authorization Letter

<http://fips201ep.cio.gov/apl.php>

Approval Authorization Letter

15 September 2008
April Giles
1800 F. Street N.W.
Washington, D.C. 20405

Re: Approval Authorization Letter
Case File Number 723

To: Ed Morris:

The Approval Authority officially approves the following Product/Service. Please add it to the Approved FIPS 201 Products and Services List

Supplier Name:	STARTEK Engineering Inc.
Name of Product or Service:	STARTEK ANSI/INCITS 378 Template Generator for PIV
Part Number:	002B0110
Hardware Version:	N/A
Software Version:	1.0
Firmware Version:	N/A

Restrictions:

- None

Sincerely,

April Giles
April Giles
Approval Authority
202.501.1123
April.giles@gsa.gov